

# Operating Instructions & User's Information Manual

# VIESSMANN

Please file in Service Binder

Vitodens 100-W

WB1A Series

Wall-mounted, natural gas-fired condensing boiler

For natural gas only

Heating input NG 29 to 100 MBH

8 to 30 kW



## VITODENS 100-W



### IMPORTANT

Read and save these instructions for future reference.



### WARNING

If the information in this manual is not followed exactly, a fire or explosion may result causing property damage, personal injury or loss of life.

Do not store or use gasoline or other flammable liquids in the vicinity of this or any other appliance.

#### WHAT TO DO IF YOU SMELL GAS

- Do not try to light any appliances.
- Do not touch any electrical switches, do not use any phone in your building.
- Immediately call your gas supplier from a neighbor's phone. Follow the gas supplier's instructions.
- If you cannot reach your gas supplier, call the fire department.

Installation and service must be performed by a qualified installer, service agency or the gas supplier.

### WARNING

Improper installation, adjustment, and/or operation could cause carbon monoxide poisoning resulting in injury or loss of life.

This product must be installed and serviced by a professional service technician who is experienced and qualified in hot water boiler installation and gas combustion.

## Safety, Installation and Warranty Requirements

Please ensure that these instructions are read and understood before commencing installation. Failure to comply with the instructions listed below and details printed in this manual can cause **product/property damage, severe personal injury, and/or loss of life**. Ensure all requirements below are understood and fulfilled (including detailed information found in manual subsections).

### ■ Licensed professional heating contractor

The installation, service, and maintenance of this equipment *must be performed* by a licensed professional heating contractor.

► Please see section entitled "Important Regulatory and Installation Requirements" in the *Installation Instructions*.



### ■ Carbon monoxide

Improper installation, service and/or maintenance can cause flue products to flow into living space. Flue products contain *poisonous* carbon monoxide gas.

► For information pertaining to the proper installation, service and maintenance of this equipment to avoid formation of carbon monoxide, please see the *Installation Instructions of the Vitodens Venting System*.



### ■ Equipment venting

Never operate boiler without an *installed venting system*. An improper venting system can cause carbon monoxide poisoning.

### ■ Warranty

Information contained in this and related product documentation must be read and followed. *Failure to do so renders warranty null and void.*



### ■ Product documentation

Read all applicable documentation before commencing installation. Store documentation near boiler in a readily accessible location for reference in the future by service personnel.

► For a listing of applicable literature, please see section entitled "Important Regulatory and Installation Requirements" in the *Installation Instructions*.



**! WARNING**

**Installers must follow local regulations with respect to installation of carbon monoxide detectors. Follow manufacturer's maintenance schedule of boiler.**

### ■ Advice to owner

Once the installation work is complete, the heating contractor must familiarize the system operator/ultimate owner with all equipment, as well as safety precautions/requirements, shut-down procedure, and the need for professional service annually before the heating season begins.

<b>General Information</b>	<b>About these Instructions</b> .....	4
<b>Safety</b>	<b>For your Safety</b> .....	4
<b>Useful Tips</b>	Overview of Controls and Indicators.....	8
	Changing Room Temperature.....	9
<b>Start-up/Operation</b>	Start-up of the Heating System.....	10
	Heating System Operation.....	10
	DHW Production.....	10
	Heating Water Temperature and System Pressure .....	11
	Switching OFF Vitodens with Frost Protection.....	12
	Shutting Down the Heating System.....	12
<b>Information</b>	Fault Diagnosis and Correction.....	13
	Fault Messages on the Display .....	13
	Service Instructions for your Heating System .....	14
	How to Save Energy .....	15
	Lighting and Operating Instructions.....	16

## About these Instructions

 Take note of all symbols and notations intended to draw attention to potential hazards or important product information. These include "WARNING", "CAUTION", and "IMPORTANT". See below.

 **WARNING**  
Indicates an imminently hazardous situation which, if not avoided, could result in death, serious injury or substantial product/property damage.

→ Warnings draw your attention to the presence of potential hazards or important product information.

 **CAUTION**  
Indicates an imminently hazardous situation which, if not avoided, may result in minor injury or product/property damage.

→ Cautions draw your attention to the presence of potential hazards or important product information.

**IMPORTANT**

→ Helpful hints for installation, operation or maintenance which pertain to the product.



→ This symbol indicates that additional, pertinent information is to be found in column three.



→ This symbol indicates that other instructions must be referenced.

## For your Safety

### ■ Operation

Before operating the boiler, make sure you fully understand its method of operation. Your heating contractor should always perform the initial start-up and explain the system. Any warranty is null and void if these instructions are not followed.

### ■ Flue gas smell

- Deactivate heating equipment.
- Open windows and doors.
- Inform your heating contractor immediately.

### ■ Working on the equipment

All personnel working on the equipment or the heating system must have the **proper qualifications** and hold all necessary licenses.

Ensure **main power** to equipment, heating system, and all external controls have been **deactivated**. **Close main gas supply valve**. Take precautions in all instances to avoid accidental activation of power during service work.

### ■ Dangerous conditions

- Deactivate main power immediately.
- Close gas supply valve.

### ■ Maintenance and cleaning

Regular inspection and service by a qualified heating contractor is important to the performance of the Viessmann Vitodens 100-W. Neglected maintenance impacts on warranty; regular inspection ensures clean, environmentally friendly and efficient operation. We recommend a maintenance contract with a qualified heating contractor.

### ■ Technical information

- Technical Data Manual
- Installation and Service Instructions
- Operating Instructions and User's Information Manual
- Vitodens Venting System Installation Instructions
- Quick Start-up Guide
- Instructions of other products utilized and installed
- Installation codes mentioned in this manual

**For your Safety (continued)**

■ **Carbon monoxide**

The U.S. Consumer Product Safety Commission strongly recommends the installation of carbon monoxide detectors in buildings in which gas-burning equipment is installed. Carbon monoxide (CO) is a colorless, odorless gas, which may be produced during incomplete combustion of fuel and/or when the flame does not receive an adequate supply of combustion air.

Carbon monoxide can cause severe personal injury or loss of life.

Therefore, carbon monoxide detectors that are in compliance with a nationally recognized standard (e.g. ANSI/UL 2034-2002, CSA 6.19-01) should be installed and maintained in buildings that contain gas-burning equipment.

*Note:*

Viessmann does not test any detectors and makes no representation regarding any brand or type of detector.

■ **For safe operation**

We recommend that you frequently:

- Check for debris which could obstruct the flow of flue gases. The vent or chimney must not be blocked. A blocked or partially blocked vent or chimney can cause flue gases to leak into the structure. Flue gases leaking into the house can cause injury or death. A qualified heating contractor must remove the blockage from blocked or partially blocked chimneys.
- Check pressure gage for correct system (water) pressure. Check for water on the floor from the discharge pipe of the pressure relief valve or any other pipe, pipe joint, valve or air vent.
- Check for moisture, water, or appearance of rust on the flue gas pipes, their joints as well as vent dampers, or side wall vent terminals (if so equipped).
- Ensure that nothing is obstructing the flow of combustion and ventilation air and no chemicals, garbage, gasoline, combustible materials, flammable vapors and liquids are stored (not even temporarily) in the vicinity of the boiler.
- Do **not** allow unsupervised children near the boiler.

Service/inspection of the boiler and the system is recommended once per year. Maintenance, service and cleaning are specified in the Installation and Service Instructions.

Before the heating season begins, it is recommended that the boiler and burner be serviced by a qualified heating contractor. Service contracts may be established through gas suppliers or other licensed contractors in your area.

 **WARNING**

As there are no user-serviceable parts on the boiler, burner or control, the end-user must not perform service activities or adjustments of any kind on system components. Failure to heed this warning can cause property damage, severe personal injury, or loss of life.

 **WARNING**

Improper installation, adjustment, service, or maintenance can cause flue products to flow into living space. Flue products contain poisonous carbon monoxide gas which can cause nausea or asphyxiation resulting in severe personal injury or loss of life.

 **CAUTION**

Should overheating occur or the gas supply fail to shut off, do not disconnect the electrical supply to the pump. Instead, shut off the gas supply at a location external to the appliance.

 **WARNING**

The operator/ultimate owner is required to have the heating boiler, burners, and controls checked, as a minimum once per year, by the original installer or by a competent heating contractor familiar with the equipment. Defects must be corrected immediately.

 **CAUTION**

Do not use this boiler if any part has been under water. Immediately call a qualified heating contractor to inspect the boiler and to replace any part of the control system and any gas control which has been under water.

**For your Safety** (continued)

**Frozen water pipe hazard**

 <b>WARNING</b>
<b>Failure to protect against frozen pipes could result in burst water pipes, serious property damage and/or personal injury. Boiler may shut down. Do not leave your home unattended for long periods of time during freezing weather conditions without turning off the water supply and draining water pipes or otherwise protecting against the risk of frozen pipes.</b>

Your heating boiler is designed to provide a warm and comfortable living environment. It is NOT designed to ensure against freezing of water pipes. The boiler is equipped with several safety devices that are designed to shut down the boiler and to prevent it from restarting in the event of various unsafe conditions.

If your boiler remains off for an extended period of time during cold weather, water pipes may freeze and burst, resulting in extensive water damage and conditions in which mold could grow. Certain molds are known to cause respiratory problems, as well as to pose other serious health risks. In case of water damage, immediate measures should be taken to dry out affected areas as quickly as possible to prevent mold from developing.

*If your home will be unattended for an extended period of time during cold weather, you should...*

- Shut off the water supply to the building, drain the water pipes and add an antifreeze for potable water to drain traps and toilet tanks. Open faucets where appropriate.

Or..

- Have someone check the building frequently during cold weather and call a qualified service agency if required.

Or...

- Install a reliable remote temperature sensor that will notify somebody of freezing conditions within the home.

**For your Safety (continued)**

**⚠ WARNING**

If you notice fire coming from the appliance, call the fire department immediately! Do not attempt to extinguish the fire unless qualified to do so.

**⚠ WARNING**

Fire causes a risk of burns and explosion!

- Shut down the boiler
- Close fuel shut-off valves
- Use a tested fire extinguisher, class ABC.

**Installation area conditions**

**⚠ WARNING**

Incorrect ambient conditions can lead to damage to the heating system and put safe operation at risk.

- Ensure ambient temperatures are higher than 32°F / 0°C and lower than 104°F / 40°C.
- Prevent the air from becoming contaminated by halogenated hydrocarbons (e.g. as contained in paints solvents or cleaning fluids) and excessive dust (e.g. through grinding or polishing work).  
Combustion air for the heating process, and ventilation of the boiler room must be free of corrosive contaminants. To that end, any boiler must be installed in an area that has no chemical exposure. The list to the right indicates the main, currently known sources.
- Avoid continuously high levels of humidity (e.g. through frequent drying of laundry).
- Never close existing ventilation openings.

**Replacement components, spare and wear parts**

**IMPORTANT**

Components which are not tested with the heating system may damage the heating system, or affect its functions. Installation or replacement may only be carried out by a qualified heating contractor.

**Sources of combustion and ventilation air contaminants**

**Areas likely to contain contaminants:**

- New building construction
- Swimming pools
- Remodelling areas, hobby rooms
- Garages with workshops
- Furniture refinishing areas
- Dry cleaning/laundry areas and establishments
- Auto body shops
- Refrigeration repair shops
- Metal fabrication plants
- Plastic manufacturing plants
- Photo processing plants
- Beauty salons

**Products containing contaminants:**

- Chlorine-type bleaches, detergents and cleaning solvents found in household laundry rooms
- Paint and varnish removers
- Hydrochloric acid, muriatic acid
- Chlorine-based swimming pool chemicals
- Spray cans containing chlorofluorocarbons
- Chlorinated waxes and cleaners
- Cements and glues
- Refrigerant leaks
- Calcium chloride used for thawing
- Sodium chloride used for water softening salt
- Permanent wave solutions
- Adhesives used to fasten building products and other similar items
- Antistatic fabric softeners used in clothes dryers

## Overview of Controls and Indicators

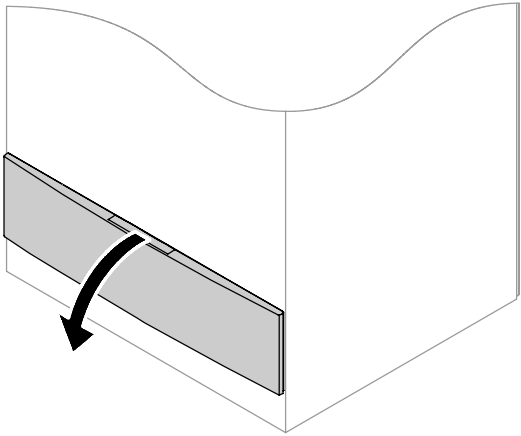

### Opening the control unit



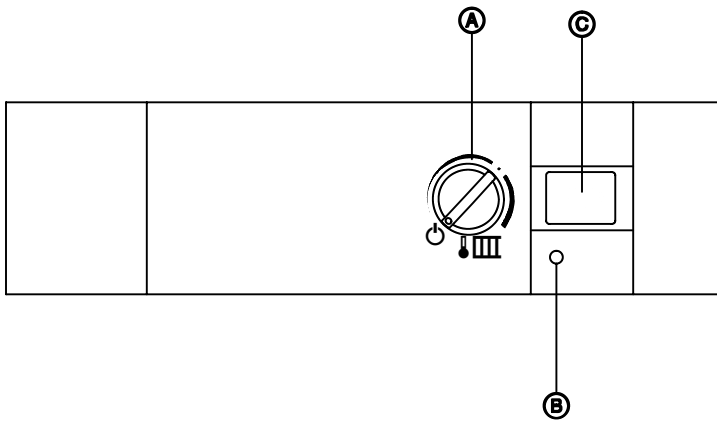

Controls and indicators are located behind the hinged front cover.



### Control and display elements

The control unit is preset at the factory for standard operation. Your heating system is ready for use. The factory presets may be individually adjusted to suit your specific requirements.

### Legend

- Ⓐ   boiler water temperature selector dial
- Ⓑ  Display, fault and reset button
- Ⓒ  LCD display



## Overview of Controls and Indicators (continued)

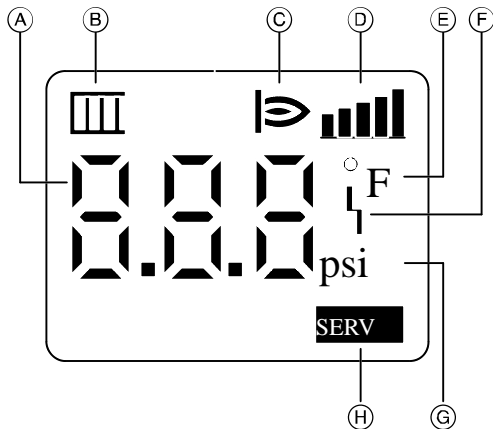

### Legend

- Ⓐ Display value or fault code
- Ⓑ Heating mode (pump on)
- Ⓒ Burner in operation
- Ⓓ Actual burner firing rate
- Ⓔ Boiler water temperature in °F (combined with display value)
- Ⓕ Fault
- Ⓖ System pressure (combined with display value)
- Ⓗ Emissions test activated (only for licensed professional heating contractor)

## Changing Room Temperature

In case a separate external room temperature controller (thermostat) is installed, the desired room temperature will be adjusted using this device.

Make adjustments using the appropriate operating instructions only.

### *Please also note:*

If thermostatic radiator valves are installed in the room where the control is installed they must be fully open.

In case the room temperature setting on the separate room temperature controller is not sufficient to achieve the desired room temperature (e.g. during a particularly cold winter), the boiler water temperature can be adjusted accordingly using the boiler water temperature selector dial .

## Start-up of the Heating System

Before you switch ON a heating system which has been switched OFF for longer periods of time, it is advisable to contact your local heating contractor.

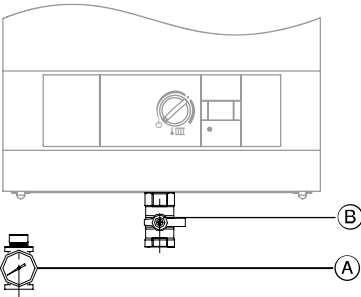
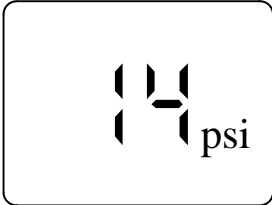

1. Switch ON the main power supply.  
*Your heating system and, if installed, your room temperature thermostat are now ready to operate.*
2. Check the pressure of the heating system by turning the selector dial “ III” to “”. The system pressure will be displayed.  
Or check the pressure gage <sup>(A)</sup> located at the bottom left corner of the boiler supply piping.  
**Minimum system pressure is 14 psig.**  
Please contact your heating contractor if the system pressure is too low.
3. Open gas shutoff valve <sup>(B)</sup>.

## Heating System Operation

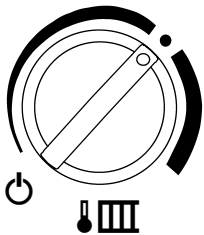

### Switching ON:

Turn the selector dial “ III” to the desired boiler water temperature.

The display “ III” indicates when room temperature has been reached.

### Switching OFF:

Turn the selector dial “ III” to “”.

### Please note:

*If an external device is connected that controls the boiler water temperature, it can no longer be adjusted using the selector dial “ III”.*

## Domestic Hot Water Production

When in operation with separate a Domestic Hot Water (DHW) tank, domestic hot water temperature is adjusted at the temperature control of the DHW tank.

## Heating Water Temperature and System Pressure

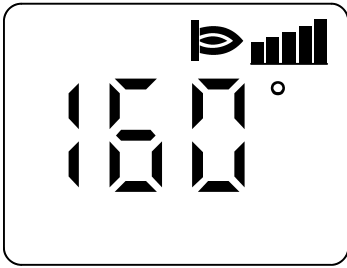

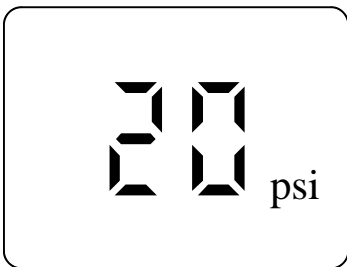

### Checking the boiler heating water temperature

During operation, heating water temperature is constantly displayed.



### Checking the system pressure

1. Turn the selector dial “ IIII” fully counter clockwise towards “”.  
The display now shows the current system pressure (e.g. 20 psig).
2. Return the selection dial back to its original position.

*Note:*

*The display will flash if the system pressure falls below 8 psig. In this instance, please contact your heating contractor.*

## Switching OFF Vitodens with Frost Protection

Switch OFF the equipment if you do not wish to use your heating system for a few days.

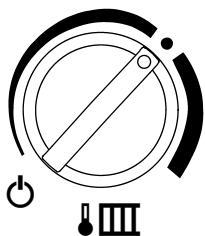

Turn selector dial “❄️” to “⏻”.  
Boiler frost protection is active.

### Frost protection

Frost protection is continuously active. The burner is switched ON when the boiler water temperature reaches 41°F / 5°C and is switched OFF again when the boiler water temperature reaches at least 59°F / 15°C (but not more than 68°F / 20°C).

## Shutting Down the Heating System

Shut down your heating system completely, if it is not needed for longer periods of time (several months).

Before you switch your heating system OFF for longer periods, it is advisable to contact your local heating contractor. Your heating professional will take any necessary measures, e.g. for freeze protection of the system or to protect the heat emitter surfaces, e.g. radiators etc.

1. Close gas shutoff valve and secure against unintentional opening.
2. Switch OFF line voltage (e.g. at separate fuse/circuit breaker).  
The power supply to the system is now switched off.

### IMPORTANT

**At this point the boiler and the system is no longer protected from freezing.**

## Fault Diagnosis and Correction

Issue	Cause	Corrective Action
Heating system does not start up	Heating system switch turned to OFF on control unit	Turn switch to ON on control unit.
	Selector dial "⏸" is set to "⏹".	Set required heating water temperature (see page 10).
	Circuit breaker or fuse in power supply or in boiler control unit has blown or tripped	Inform heating contractor.
Burner does not switch on or only intermittently	No gas	Open gas shut-off valve or contact your gas supply company.
	Fault on control unit	Make a note of the fault code and inform heating contractor.
Burner does not start up; red burner fault lamp "F" is lit on control unit	Faulty start-up	Press burner fault reset button (see page 8). Should this attempt fail, contact your heating contractor.
	Low water level	System operating pressure is flashing on the display. Inform heating contractor.
Burner does not start up; burner fault lamp "F" appears in display	Power supply too low	Contact your Hydro company.
The burner switches off even though the desired room temperature has not been reached	Fault in combustion air supply or in the venting system	Contact your heating contractor.
	Heating water temperature or room temperature is set too low	Increase heating water temperature by turning selector dial "⏸" or by increasing desired room temperature on the room thermostat.
Rooms are cold although burner is operating	Domestic hot water supply has priority (operation with DHW storage tank only)	Wait until the domestic hot water heating is complete.
	Fault on programmable room thermostat	Contact your heating contractor.

## Fault Messages on the Display

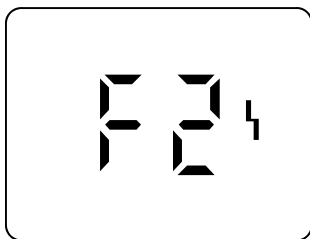

Any faults in your heating system are indicated on the display by a flashing fault symbol "F".

Read off the fault code in the display and report it to your heating contractor. This helps the contractor to properly prepare, and may result in lower service costs.

### Warning

Visually inspect the vent termination for any signs of blockage. Under cold climate conditions (sustained temperatures below 0°F / -18°C) the vent termination may be severely blocked by icicle and frost build-up. The boiler control will automatically shut down the boiler should air intake or vent be blocked. Remove blockage if possible. Reset the boiler and the boiler should attempt to restart. If blockage is not obvious and cannot be removed, contact a licensed professional heating contractor.

## Service Instructions for Your Heating System

*Viessmann strongly recommends inspection/service of the boiler and the system by a licensed professional heating contractor once per year.*

*Before the heating season begins, the boiler with its burner(s) and vent system should be serviced by a qualified heating contractor. Service contracts may be established through gas suppliers or other licensed contractors in your area.*

*Regular inspection/service ensures troublefree, energy-efficient and environmentally friendly heating activity of your heating system.*

### **Boiler**

All boilers must be cleaned on a regular basis as debris build-up will result in increased flue gas temperature, and thus in increased energy consumption.

### → **Notes on operation:**

- *Ensure boiler room and boiler are clean.*
- *Regularly check heating system pressure on the pressure gage: If the system operating pressure gage is indicating a pressure of below 14 psig, the system pressure is too low; in this case, please contact your heating contractor.*

### **Viessmann domestic hot water storage tank**

Inspection and (if necessary) cleaning of the tank must take place within 2 years of initial start-up and every 2 years thereafter.

Cleaning of the inside surfaces of the domestic hot water storage tank, including domestic hot water connections, may only be performed by an licensed professional heating contractor.

Vitocell 100:

Viessmann recommends an annual inspection, and replacement if required, of the consumable anode by a licensed professional heating contractor.

The inspection can be carried out during regular operation of the heating system; shut-down is not required.

The heating contractor measures the protective current with an anode testing instrument.

### **Drinking water filter** (if installed)

For hygienic reasons

- replace filter element every 6 months on filters which cannot be flushed back, and perform a visual inspection every 2 months,
- flush back reversible flow filters every 2 months.

## **IMPORTANT**

**If a water treatment device (water softener) is installed in the domestic cold water supply to the hot water storage tank, ensure its proper working condition is checked regularly by your heating contractor.**

**The same applies if a dirt trap or a water filter is installed in the domestic cold water supply. Any of these devices installed in the domestic cold water supply must be flushed out and serviced on a regular basis.**

→ *Please follow manufacturer's instructions.*

## How to Save Energy

### .... by heating the right way

Apart from taking advantage of the benefits of a modern heating system, there is a lot you can do yourself to achieve additional fuel savings. For instance:

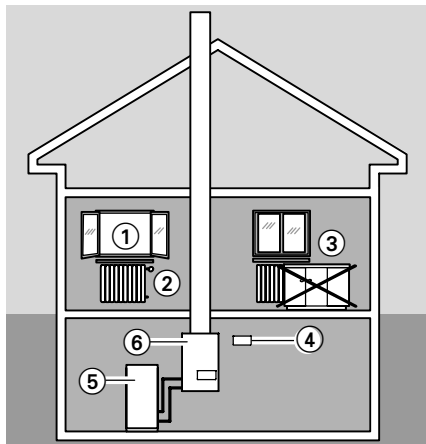

- Don't overheat:  
Aim at a room temperature of 68 °F/20 °C. Every 2 °F/1 °C less in room temperature will reduce your heating bills by up to 6 %.
- Close window shutters (if installed) at dusk.
- Operate thermostatic valves ② correctly.
- Don't obstruct radiators ③ and thermostatic valves ②.
- Make use of individual adjustment options of the control unit ④ (supplied by others);  
e.g. "normal room temperature" alternating with "reduced room temperature".
- Set the domestic hot water temperature of the DHW tank ⑤ on the control unit of the tank or on external controller.
- Control your consumption of hot water:  
A shower generally consumes less energy than a bath.

### ... with regular maintenance

Regular maintenance check-ups of your heating system ⑥ by a licensed professional heating contractor will ensure energy savings and environmentally friendly operation.

### .... with effective insulation

If you wish to make use of additional energy-saving measures, check the thermal insulation:

- of heating and domestic hot water pipes.
- of external walls and the roof.
- between heated and unheated rooms.
- of the windows.

## Lighting and Operating Instructions

### FOR YOUR SAFETY READ BEFORE OPERATING

**WARNING:** If you do not follow these instructions exactly, a fire or explosion may result causing property damage, personal injury or loss of life.

- A. This appliance does not have a pilot. It is equipped with an ignition device which automatically lights the burner. Do not try to light the burner by hand.
- B. **BEFORE OPERATING** smell all around the appliance area for gas. Be sure to smell next to the floor because some gas is heavier than air and will settle on the floor.

#### WHAT TO DO IF YOU SMELL GAS

- Do not try to light any appliance.
- Do not touch any electric switch; do not use any phone in your building.
- Immediately call your gas supplier from a neighbor's phone. Follow the gas supplier's instructions.
- If you cannot reach your gas supplier, call the fire department.

- C. Use only your hand to push in or turn the gas control knob. Never use tools. If the knob will not push in or turn by hand, don't try to repair it, call a qualified service technician. Force or attempted repair may result in a fire or explosion.
- D. Do not use this appliance if any part has been under water. Immediately call a qualified service technician to inspect the appliance and to replace any part of the control system and any gas control which has been under water.

### OPERATING INSTRUCTIONS

1. **STOP!** Read the safety information above on this label.
2. Set thermostat or other operating control to lowest setting.
3. Turn off all electric power to the appliance.
4. This device is equipped with an ignition device which automatically lights the burner. Do not try to light the burner by hand.

#### Manual gas shutoff

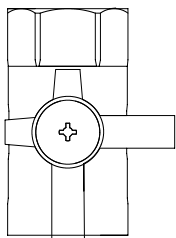

Open

Closed

5. Close main gas shut-off valve.
6. Wait five (5) minutes to clear out any gas. Then smell for gas, including near the floor. If you smell gas, **STOP!** Follow "B" in the safety information above on this label. If you don't smell gas, go to the next step.
7. Open main gas shut-off valve.
8. Turn on all electric power to the appliance.
9. Set thermostat or other operating control to desired setting.
10. If the appliance will not operate, follow the instructions "To Turn Off Gas To Appliance" and call your service technician or gas supplier.

### TO TURN OFF GAS TO BOILER

1. Set thermostat or other operating control to lowest setting.
2. Turn off all electric power to the appliance if service is to be performed.
3. Close main gas shut-off valve.









## Quick Reference

°C	°F
-40	-40
-35	-31
-25	-13
-20	-4
-18	0
-16	+3
-14	+7
-12	+10
-10	+14
-9	+16
-8	+18
-7	+19
-6	+21
-5	+23
-4	+25
-3	+27
-2	+28
-1	+30
0	+32
+1	+34
+2	+36
+3	+37
+4	+39
+5	+41
+6	+43
+7	+45
+8	+46
+9	+48
+10	+50
+12	+54
+14	+57
+16	+61
+18	+64
+20	+68
+25	+77
+30	+86
+35	+95
+40	+104
+50	+122
+60	+140
+70	+158
+80	+176
+90	+194
+100	+212
+110	+230

Printed on environmentally friendly  
(recycled and recyclable) paper.



Technical information subject to change without notice

Viessmann Manufacturing Company (U.S.) Inc.  
45 Access Road  
Warwick, Rhode Island • 02886 • USA  
Tel. (401) 732-0667 • Fax (401) 732-0590  
www.viessmann-us.com • mail@viessmann-us.com

Viessmann Manufacturing Company Inc.  
750 McMurray Road  
Waterloo, Ontario • N2V 2G5 • Canada  
Tel. (519) 885-6300 • Fax (519) 885-0887  
www.viessmann.ca • mail@viessmann.ca

5581 532 v1.1